

ABSOLUTE MAXIMUM RATINGS

Item	Symbol	Min.	Max.	Unit
Supply Voltage(Logic)	$V_{DD} - V_{SS}$	-0.3	5.6	V
Input Voltage	V_I	-0.3	$V_{DD} + 0.3$	V
Operating Temp.	T_{opr}	-40	80	°C
Storage Temp.	T_{stg}	-40	80	°C

MECHANICAL DATA

Item	Nominal Dimensions	Unit
Module Size (W x H x T)	98.0 x 60.0 x 9.5	mm
Viewing Area (W x H)	73.0 x 24.0	mm
Character Size (W x H)	2.97 x 4.77	mm
Dot Size (W x H)	0.57 x 0.57	mm
Weight	Approx. 38	g

ELECTRICAL CHARACTERISTICS ($V_{DD}=3.3V$ to $5.5V$)

Item	Symbol	Test Condition	Min.	Typ.	Max.	Unit
Input High Voltage	V_{IH}	--	$0.7V_{DD}$	--	V_{DD}	V
Input Low Voltage	V_{IL}	--	0	--	$0.3V_{DD}$	V
Output High Voltage	V_{OH}	$I_{OH} = -0.5mA$	$0.7V_{DD}$	--	V_{DD}	V
Output Low Voltage	V_{OL}	$I_{OL} = 0.5mA$	0	--	$0.3V_{DD}$	V
OLED Driving Voltage	V_{PP}	--	--	12.0	12.5	V
Supply Current	$I_{DD}^{Note 1}$	$V_{DD} = 5.0V$	--	42.0	52.0	mA
	$I_{DD}^{Note 2}$	$V_{DD} = 3.3V$	--	35.0	44.0	mA

Note 1: 50% display area turned on, contrast register is set to 80H
 Note 2: 50% display area turned on, contrast register is set to CFH

BLOCK DIAGRAM

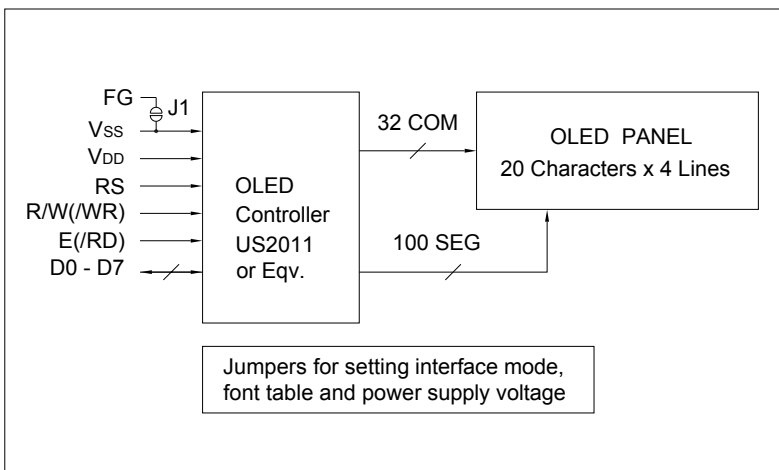

PIN CONNECTIONS (CN1/CN2)

Pin	Symbol	Level	Function
1	V_{SS}	0V	GND
2	V_{DD}	3.3V to 5.5V	Power supply for logic JV1 open : $V_{DD}=3.5V$ to $5.5V$ JV1 close : $V_{DD}=3.3V$ to $3.5V$
3	NC	--	No connection
4	RS	H/L	Data or command selection H : Display data L : Command code
5	R/W (/WR)	H/L	R/W for 68 MPU. "H": Read; "L": Write /WR for 80 MPU. Write data at the rising edge of /WR.
6	E (/RD)	H/L	Enable for 68 MPU. Read data when E is "H"; write data at the falling edge. /RD for 80 MPU. Active "L".
7	D0	H/L	In 8-bit bus mode, used as low order bidirectional data bus. In 4-bit bus mode, open these pins.
8	D1	H/L	
9	D2	H/L	
10	D3	H/L	
11	D4	H/L	In 8-bit bus mode, used as high order bidirectional data bus. In 4-bit bus mode, used as both high and low order data bus.
12	D5	H/L	
13	D6	H/L	
14	D7	H/L	
15	NC (/CS)	-- L	No connection for 68 MPU. Chip selection for 80 MPU. Active "L".
16	NC (/RES)	-- L	No connection for 68 MPU. Reset signal for 80 MPU. Active "L".