

LC1621-DY

16 characters x 2 lines + yellow green led backlight, 4/8-bit parallel, 5V

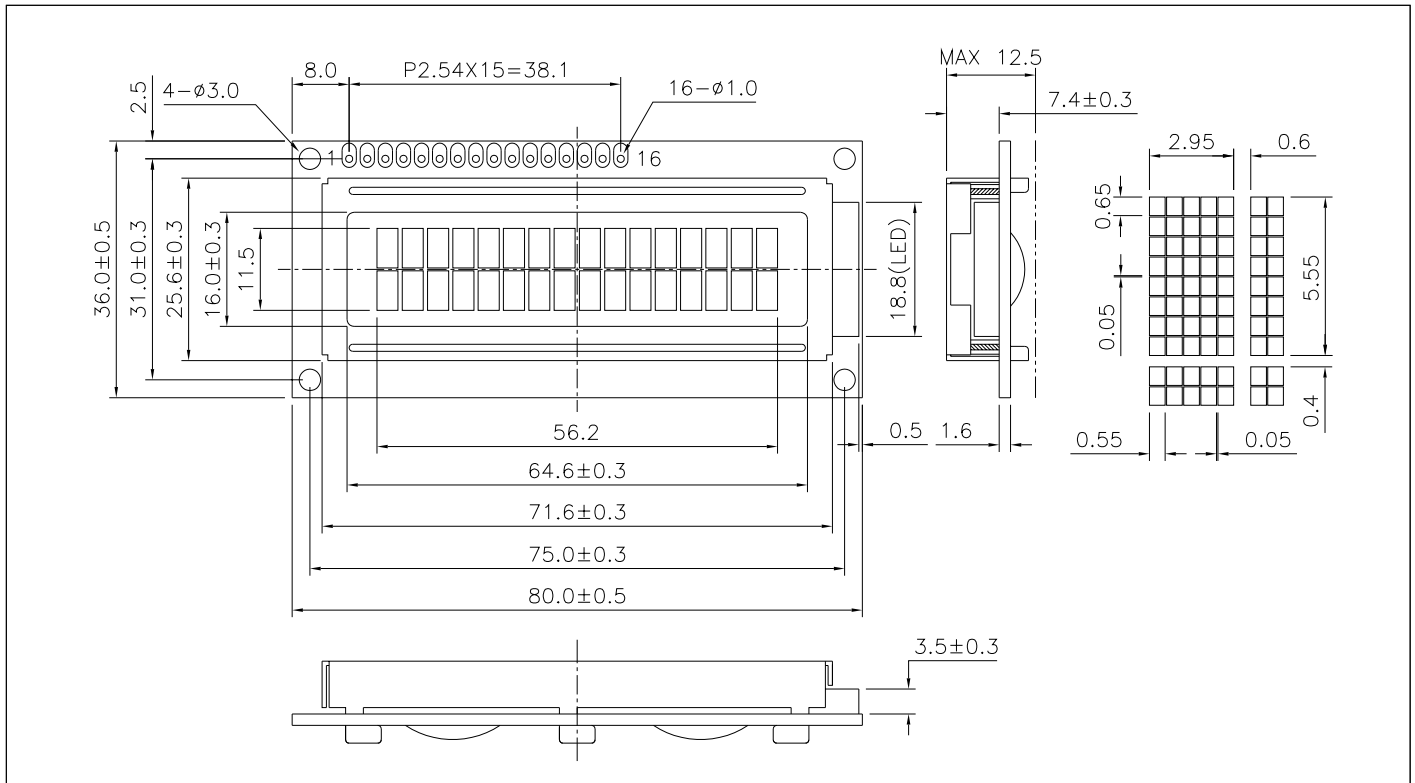

ABSOLUTE MAXIMUM RATINGS

Item	Symbol	Min.	Max.	Unit
Supply Voltage(Logic)	$V_{DD} - V_{SS}$	-0.3	7.0	V
Supply Voltage(LCD)	$V_{DD} - V_o$	-0.3	10.0	V
Input Voltage	V_i	-0.3	$V_{DD} + 0.3$	V
Operating Temp.	T_{opr}	-20	70	°C
Storage Temp.	T_{stg}	-30	80	°C

MECHANICAL DATA

Item	Nominal Dimensions	Unit
Module Size (W x H x T)	80.0 x 36.0 x 12.5	mm
Viewing Area (W x H)	64.6 x 16.0	mm
Character Size (W x H)	2.95 x 5.55	mm
Dot Size (W x H)	0.55 x 0.65	mm
Weight	Approx. 36	g

ELECTRICAL CHARACTERISTICS ($V_{DD}=5V\pm 0.25V$)

Item	Symbol	Test Condition	Min.	Typ.	Max.	Unit
Input High Voltage	V_{IH}	--	2.5	--	V_{DD}	V
Input Low Voltage	V_{IL}	--	-0.3	--	0.6	V
Output High Voltage	V_{OH}	$I_{OH} = -0.1mA$	2.4	--	V_{DD}	V
Output Low Voltage	V_{OL}	$I_{OL} = 0.1mA$	0	--	0.4	V
Supply Current	I_{DD}	$V_{DD} = 5.0V$	--	1.5	3.0	mA
LCD Driving Voltage	$V_{DD} - V_o$	$T_a = 25^\circ C$	--	4.6	--	V

PIN CONNECTIONS

Pin	Symbol	Level	Function
1	V_{SS}	0V	GND
2	V_{DD}	5V	Power supply for logic
3	V_o	--	Operating voltage for LCD
4	RS	H/L	H : Data L : Instruction code
5	R/W	H/L	H : Read L : Write
6	E	H, H>L	Enable signal Read data when E is high Write data at falling edge of E
7	DB0	H/L	In 8-bit bus mode, used as low order bidirectional data bus. In 4-bit bus mode, open these pins.
8	DB1	H/L	
9	DB2	H/L	
10	DB3	H/L	
11	DB4	H/L	In 8-bit bus mode, used as high order bidirectional data bus.
12	DB5	H/L	
13	DB6	H/L	In 4-bit bus mode, used as both high and low order data bus.
14	DB7	H/L	
15	LEDA	5V	Power supply for LED backlight
16	LEDK	0V	

BLOCK DIAGRAM

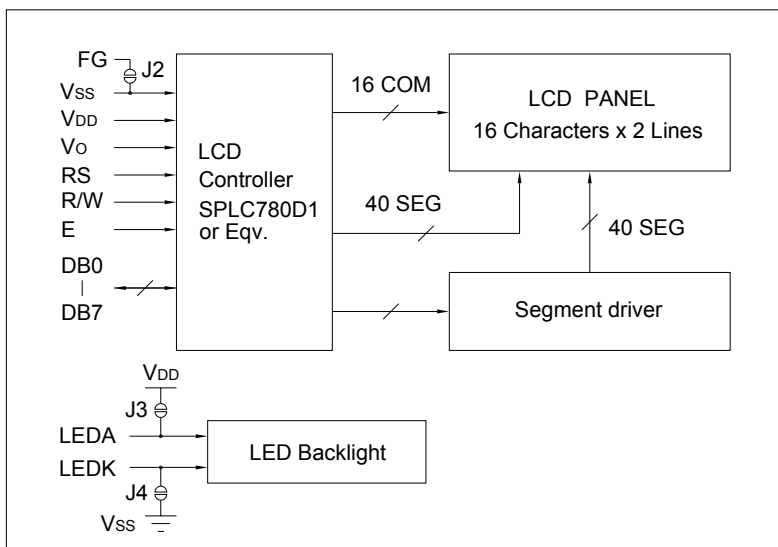

LED BACKLIGHT SPECIFICATIONS ($T_a = 25^\circ C$)

Item	Symbol	Typ.	Max.	Unit
Forward Voltage	V_f	2.8	3.0	V
Forward Current	I_f	12	--	mA
LED Color		Yellow Green		